

**Caratteristiche:**

Griglie di transito, passo 20 mm.

**Costruzione:**

Alluminio anodizzato.

**Impiego:**

Per il transito dell'aria attraverso porte o su pareti in cartongesso.

**Fissaggio:**

- Fissaggio con viti a vista.

**Accessori:**

- Controcornice.

**Characteristics:**

Transit grilles, 20 mm pitch.

**Construction:**

Anodized aluminium.

**Utilization:**

For the air flow transit by doors and thin walls.

**Fixing:**

- Fixing by using frontal screws.

**Accessories:**

- Auxiliary frame.

**PREZZI / PRICES**

		GTA	GTA-C	C
BxH (mm)		€	€	€
* 200x100		-	-	-
* 300x100		-	-	-
* 400x100		-	-	-
* 500x100		-	-	-
* 600x100		-	-	-
700x100		-	-	-
800x100		-	-	-
900x100		-	-	-
1000x100		-	-	-
* 300x160		-	-	-
* 400x160		-	-	-
* 500x160		-	-	-
* 600x160		-	-	-
700x160		-	-	-
800x160		-	-	-
900x160		-	-	-
1000x160		-	-	-
* 200x200		-	-	-
* 300x200		-	-	-
* 400x200		-	-	-
* 500x200		-	-	-
* 600x200		-	-	-
700x200		-	-	-
800x200		-	-	-
900x200		-	-	-
1000x200		-	-	-
* 300x300		-	-	-
* 400x300		-	-	-
* 500x300		-	-	-
* 600x300		-	-	-
* 400x400		-	-	-
* 500x400		-	-	-
* 600x400		-	-	-
700x400		-	-	-
800x400		-	-	-
900x400		-	-	-
1000x400		-	-	-

**DESCRIZIONI:**

GTA: Griglia priva di controcornice

GTA-C: Griglia con controcornice

C: Controcornice

**VERNICIATURA:**

**PAINTING:**

**DESCRIPTIONS:**

GTA: Grille without auxiliary frame

GTA-C: Grille with auxiliary frame

C: Auxiliary frame

DISEGNI / DRAWINGS

GTA-C

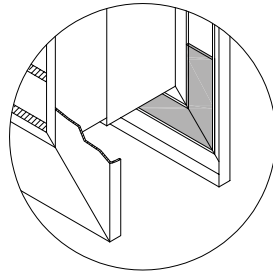
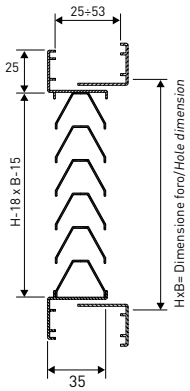

PARTICOLARE INSERIMENTO CONTROCORNICE  
PARTICULAR INSERTION COUNTERFRAME

TIPO DI FISSAGGIO / TYPE OF FIXING

Fissaggio con viti  
Fixing with screws

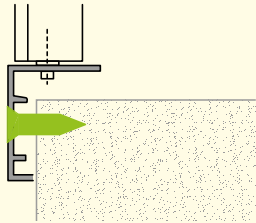

STANDARD

FORI / HOLES

2 Fori / Holes

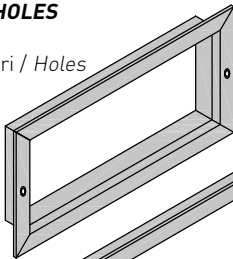

4 Fori / Holes

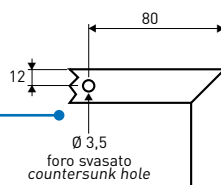
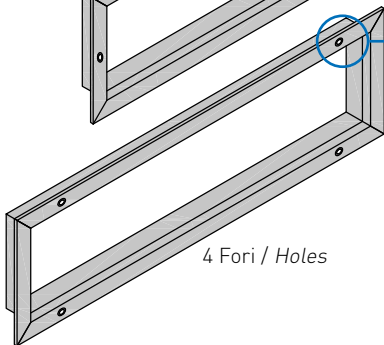

Quantità di fori per le viti di fissaggio Amount of holes for mounting screw					
Lato minore Smaller side	Lato maggiore / Longer side				
	200	250	300	350	≥400
100	2	2	2	4	4
150	2	2	2	4	4
200	2	2	2	4	4
≥250	2	2	2	4	4

DIAGRAMMA SCELTA RAPIDA / QUICK SELECTION DIAGRAM

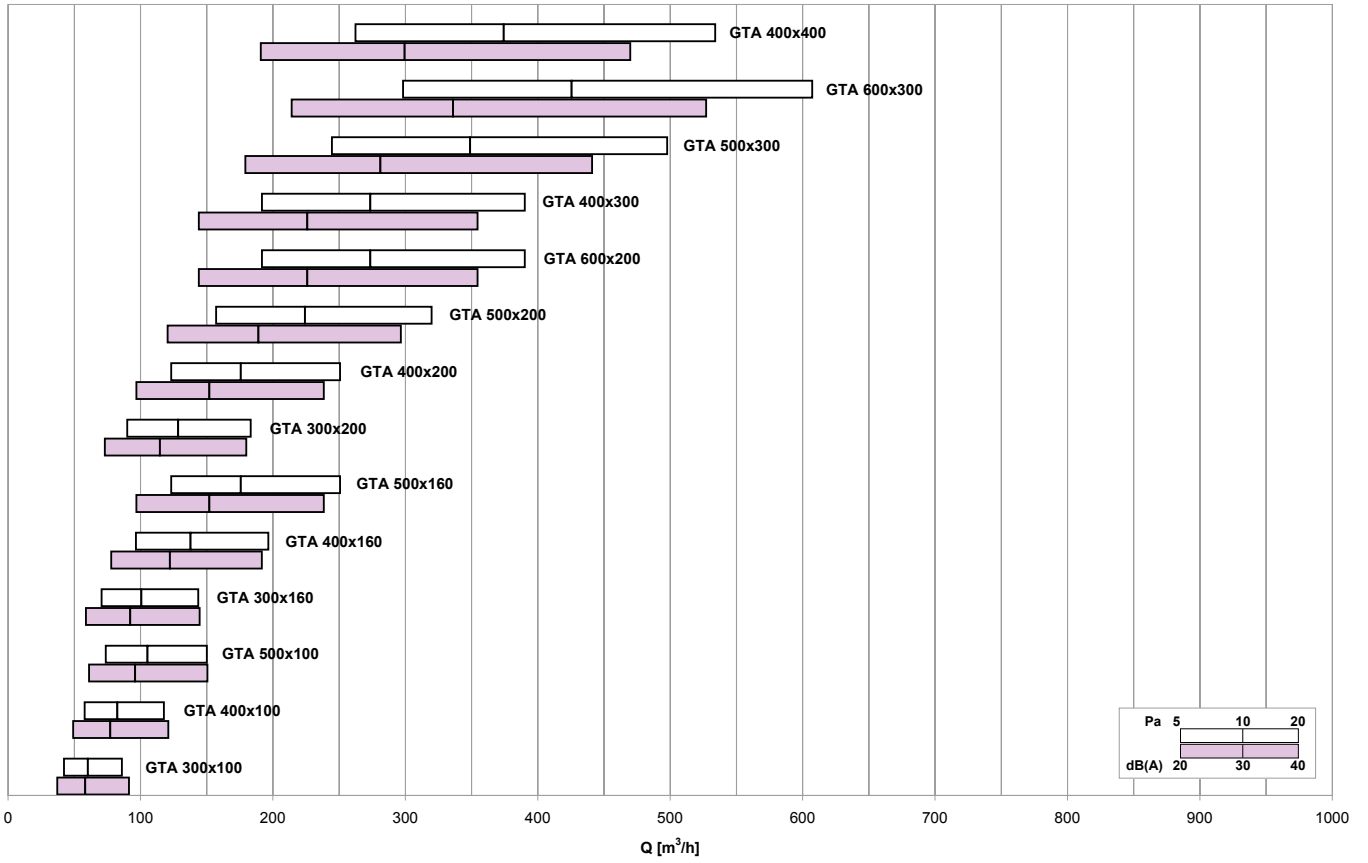

TABELLA DI SELEZIONE / SELECTION TABLE

Modello Model	A <sub>v</sub> [m <sup>2</sup> ]	Q [m <sup>3</sup> /h]		L <sub>wa</sub> [dB(A)]		Dp <sub>t</sub> [Pa]	
		min	max	min	max	min	max
<b>GTA 200x100</b>	0,0140	30	60	24	39	5	20
<b>GTA 300x100</b>	0,0209	40	90	22	40	5	20
<b>GTA 400x100</b>	0,0276	60	120	24	40	5	20
<b>GTA 500x100</b>	0,0344	70	150	23	40	5	20
<b>GTA 600x100</b>	0,0411	90	180	25	40	5	20
<b>GTA 700x100</b>	0,0478	110	220	26	41	5	20
<b>GTA 800x100</b>	0,0545	120	250	25	41	5	20
<b>GTA 900x100</b>	0,0611	140	290	26	42	5	20
<b>GTA 1000x100</b>	0,0678	160	320	26	42	5	20
<b>GTA 300x160</b>	0,0330	70	140	24	39	5	20
<b>GTA 400x160</b>	0,0438	100	200	26	41	5	20
<b>GTA 500x160</b>	0,0545	120	250	25	41	5	20
<b>GTA 600x160</b>	0,0651	150	310	26	42	5	20
<b>GTA 700x160</b>	0,0757	180	360	26	42	5	20
<b>GTA 800x160</b>	0,0863	210	420	27	42	5	20
<b>GTA 900x160</b>	0,0968	230	480	26	43	5	20
<b>GTA 1000x160</b>	0,1073	260	530	27	43	5	20
<b>GTA 200x200</b>	0,0276	60	120	24	40	5	20
<b>GTA 300x200</b>	0,0411	90	180	25	40	5	20
<b>GTA 400x200</b>	0,0545	120	250	25	41	5	20
<b>GTA 500x200</b>	0,0678	160	320	26	42	5	20
<b>GTA 600x200</b>	0,0810	190	390	26	42	5	20
<b>GTA 700x200</b>	0,0942	230	460	27	42	5	20
<b>GTA 800x200</b>	0,1073	260	530	27	43	5	20
<b>GTA 900x200</b>	0,1204	300	610	27	43	5	20
<b>GTA 1000x200</b>	0,1335	330	680	27	43	5	20
<b>GTA 300x300</b>	0,0611	140	290	26	42	5	20
<b>GTA 400x300</b>	0,0810	190	390	26	42	5	20
<b>GTA 500x300</b>	0,1007	240	500	26	43	5	20
<b>GTA 600x300</b>	0,1204	300	610	27	43	5	20
<b>GTA 400x400</b>	0,1073	260	530	27	43	5	20
<b>GTA 500x400</b>	0,1335	330	680	27	43	5	20
<b>GTA 600x400</b>	0,1595	410	830	28	44	5	20
<b>GTA 700x400</b>	0,1855	480	980	28	44	5	20
<b>GTA 800x400</b>	0,2114	560	1140	29	45	5	20
<b>GTA 900x400</b>	0,2372	640	1290	29	45	5	20
<b>GTA 1000x400</b>	0,2629	710	1450	29	45	5	20