

# VSV / VSVI

VSV

VSVI

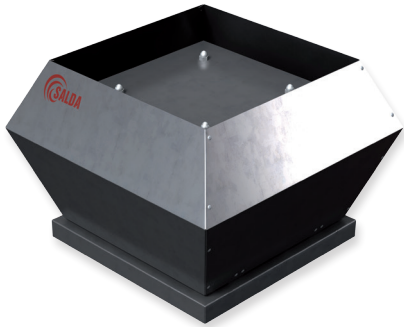

<b>Features</b>	<ul style="list-style-type: none"> <li>› 9 sizes;</li> <li>› Airflow up to 15300 m<sup>3</sup>/h;</li> <li>› Vertical exhaust;</li> <li>› Backward-curved plastic or galvanized steel impeller;</li> <li>› Acoustically insulated VSVI version;</li> <li>› Cost-effective.</li> </ul>
<b>Power supply</b>	230V/50Hz/1f or 400V/50Hz/3f.
<b>Temperature range</b>	From -25°C up to 40/60°C, depending on size.
<b>Sizes</b>	250-2S L1, 311-4 L1, 311-4 L3, 355-4 L1, 355-4 L3, 400-4 L1, 400-4 L3, 450-4 L1, 450-4 L3, 450-6 L1, 450-6 L3, 500-4 L3, 500-6 L3, 560-4 L3, 560-6 L3, 630-4 L3, 630-6 L3, 630-8 L3, 710-6 L3, 710-8 L3.
<b>Construction</b>	<ul style="list-style-type: none"> <li>› Casing: galvanized steel or aluminium;</li> <li>› Motor protected from external objects;</li> <li>› Acoustic and thermal wall insulation – 50mm (VSVI only);</li> <li>› Fan: centrifugal impeller and external rotor motor;</li> <li>› Motor protection with built-in thermal-contact;</li> <li>› Motor protection class: IP44/ IP54 depending on unit;</li> <li>› Terminal box protection class: IP55.</li> </ul>
<b>Installation</b>	<ul style="list-style-type: none"> <li>› Device can be connected to pull air directly from ventilated room or air duct system.</li> <li>› Not suitable for polluted air or volatile and explosive gases.</li> </ul>
<b>Speed control options</b>	<ul style="list-style-type: none"> <li>› Electronic voltage controller (phase cut).</li> <li>› Voltage controlled speed controller.</li> </ul>

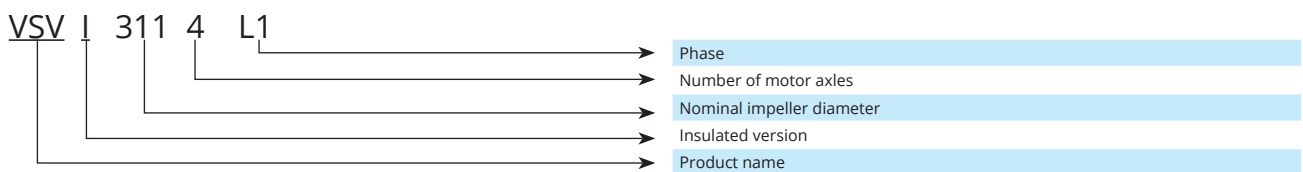

## Accessories

Single phase speed controller	Three phase speed controller	Single phase speed controller	Roof curb	Roof curb	Flange-adapter
TGRV p. 127	TGRT p. 127	ETY/MTY p. 128	KS-K p.133	KSP-K p. 134	FSV p. 137

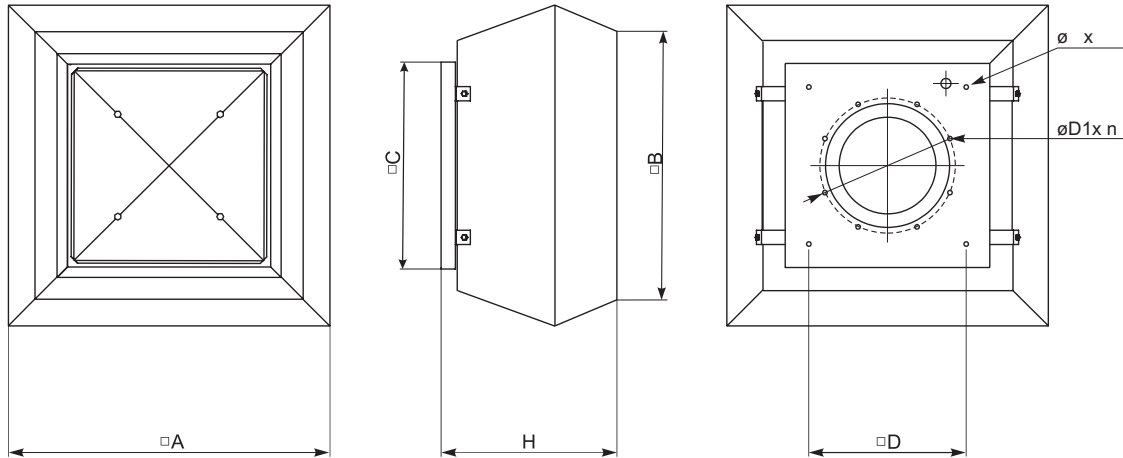

Type	Dimensions [mm]							
	□ A	□ B	□ C	H	∅M	□ D	∅D1	n
VSV 250	415	320	355	275	M6	245	230	6
VSV 311	555	470	435	323	M6	330	285	6
VSV 355	720	618	595	420	M10	450	438	6
VSV 400	720	618	595	420	M10	450	438	6
VSV 450	900	700	665	485	M10	535	438	6
VSV 500	900	700	665	485	M10	535	438	6
VSV 560	1150	972	939	609	M10	750	605	8
VSV 630	1150	972	939	609	M10	750	605	8
VSV 710	1350	1176	1040	717	M10	840	674	8

Type	Dimensions [mm]							
	□ A	□ B	□ C	H	∅M	□ D	∅D1	n
VSVI 311	675	567	435	369	M6	330	285	6
VSVI 355	844	716	595	422	M10	450	438	6
VSVI 400	844	716	595	422	M10	450	438	6
VSVI 450	966	817	665	488	M10	535	438	6
VSVI 500	966	817	665	488	M10	535	438	6
VSVI 560	1265	1033	939	611	M10	750	605	8
VSVI 630	1265	1033	939	611	M10	750	605	8
VSVI 710	1447	1178	1040	747	M10	840	674	8

Type	Accessories									
	TGRV	TGRT	ETY/MTY	KS-K	KSP-K	FSV	LSV	ATS	Main switch	
VSV 250-2S L1	1,5	-	1,5	250	250	250	250	250	BWS316 Y TPN	
VSV/VSVI 311-4 L1	1,5	-	1,5	311	311	311	311	311	BWS316 Y TPN	
VSV/VSVI 311-4 L3	-	1	-	311	311	311	311	311	BWS316 Y TPN	
VSV/VSVI 355-4 L1	2	-	2,5	355/400	355/400	355-500	355/500	355/500	BWS316 Y TPN	
VSV/VSVI 355-4 L3	-	1	-	355/400	355/400	355-500	355/500	355/500	BWS316 Y TPN	
VSV/VSVI 400-4 L1	3	-	4	355/400	355/400	355-500	355/500	355/500	BWS316 Y TPN	
VSV/VSVI 400-4 L3	-	1	-	355/400	355/400	355-500	355/500	355/500	BWS316 Y TPN	
VSV/VSVI 450-4 L1	5	-	-	450/500	450/500	355-500	355/500	355/500	BWS316 Y TPN	
VSV/VSVI 450-4 L3	-	2	-	450/500	450/500	355-500	355/500	355/500	BWS316 Y TPN	
VSV/VSVI 450-6 L1	-	-	-	450/500	450/500	355-500	355/500	355/500	BWS316 Y TPN	
VSV/VSVI 450-6 L3	-	1	-	450/500	450/500	355-500	355/500	355/500	BWS316 Y TPN	
VSV/VSVI 500-4 L3	-	4	-	450/500	450/500	355-500	355/500	355/500	BWS316 Y TPN	
VSV/VSVI 500-6 L3	-	2	-	450/500	450/500	355-500	355/500	355/500	BWS316 Y TPN	
VSV/VSVI 560-4 L3	-	5	-	560/630	560/630	560-630	560/630	560/630	BWS316 Y TPN	
VSV/VSVI 560-6 L3	-	2	-	560/630	560/630	560-630	560/630	560/630	BWS316 Y TPN	
VSV/VSVI 630-4 L3	-	11	-	560/630	560/630	560-630	560/630	560/630	BWS316 Y TPN	
VSV/VSVI 630-6 L3	-	4	-	560/630	560/630	560-630	560/630	560/630	BWS316 Y TPN	
VSV/VSVI 630-8 L3	-	2	-	560/630	560/630	560-630	560/630	560/630	BWS316 Y TPN	
VSV/VSVI 710-6 L3	-	7	-	710	710	710	710	710	BWS316 Y TPN	
VSV/VSVI 710-8 L3	-	3	-	710	710	710	710	710	BWS316 Y TPN	



# VSV / VSVI

## VSV 250-2S L1

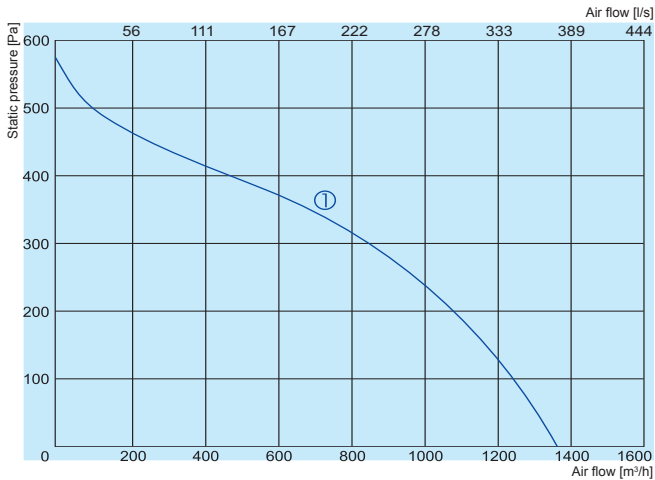

① 230V

### 250-2S L1

Inlet  
Outlet  
Surrounding

Lwa total, dB(A)	Lwa, dB(A)						
	125 Hz	250 Hz	500 Hz	1 kHz	2 kHz	4 kHz	8 kHz
Inlet	67	54	56	61	62	60	59
Outlet	71	56	61	64	67	65	58
Surrounding	65	49	56	57	60	58	46

Measured at 1155 m³/h, 100 Pa

## VSV/VSVI 311-4 L1

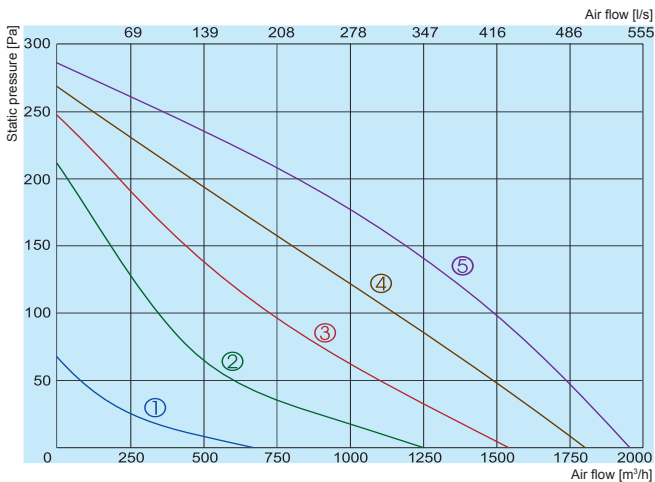

① 80V      ③ 140V      ⑤ 230V  
② 120V      ④ 170V

### VSV 311-4 L1

Inlet  
Outlet  
Surrounding

Lwa total, dB(A)	Lwa, dB(A)						
	125 Hz	250 Hz	500 Hz	1 kHz	2 kHz	4 kHz	8 kHz
Inlet	69	52	64	66	56	55	41
Outlet	68	52	59	65	60	57	45
Surrounding	71	55	64	69	62	58	46

Measured at 1511 m³/h, 100 Pa

### VSVI 311-4 L1

Inlet  
Outlet  
Surrounding

Lwa total, dB(A)	Lwa, dB(A)						
	125 Hz	250 Hz	500 Hz	1 kHz	2 kHz	4 kHz	8 kHz
Inlet	68	50	63	65	56	53	40
Outlet	67	51	57	64	59	56	43
Surrounding	70	54	64	68	60	58	44

Measured at 1511 m³/h, 100 Pa

## VSV/VSVI 311-4 L3

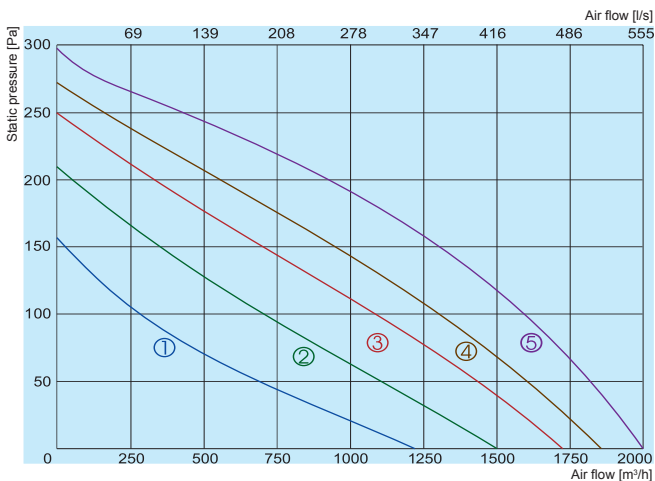

① 130V      ③ 220V      ⑤ 400V  
② 170V      ④ 270V

### VSV 311-4 L3

Inlet  
Outlet  
Surrounding

Lwa total, dB(A)	Lwa, dB(A)						
	125 Hz	250 Hz	500 Hz	1 kHz	2 kHz	4 kHz	8 kHz
Inlet	70	51	62	68	60	52	43
Outlet	69	52	60	67	59	60	44
Surrounding	72	55	63	70	64	57	47

Measured at 1706 m³/h, 75 Pa

### VSVI 311-4 L3

Inlet  
Outlet  
Surrounding

Lwa total, dB(A)	Lwa, dB(A)						
	125 Hz	250 Hz	500 Hz	1 kHz	2 kHz	4 kHz	8 kHz
Inlet	69	50	62	67	58	52	41
Outlet	68	50	59	66	58	53	43
Surrounding	71	54	63	69	62	57	45

Measured at 1706 m³/h, 75 Pa

		250-2 L1	250-2S L1	311-4 L1	311-4 L3
Voltage/Frequency	[V/Hz]	230/50	230/50	230/50	400/50
Power consumption	[kW]	0,23	0,185	0,183	0,153
Current	[A]	1,00	0,81	0,83	0,35
Speed	[min <sup>-1</sup> ]	2631	2650	1310	1370
Capacitor	[μF]	6	8	4	-
Max. airflow	[m <sup>3</sup> /h]	1428	1350	1957	2010
Min./Max. air temperature	[°C]	-25/60	-25/50	-25/60	-25/60
Weight	[kg]	8,3	8,1	19/26	19/26
Wiring diagram		No. 4	No. 3	No. 1	No. 2
Protection class:	motor	IP-44	IP-44	IP-44	IP-44
	terminal box	IP-55	IP-55	IP-55	IP-55
Comply with ERP		-	-	-	2018

## VSV/VSVI 355-4 L1

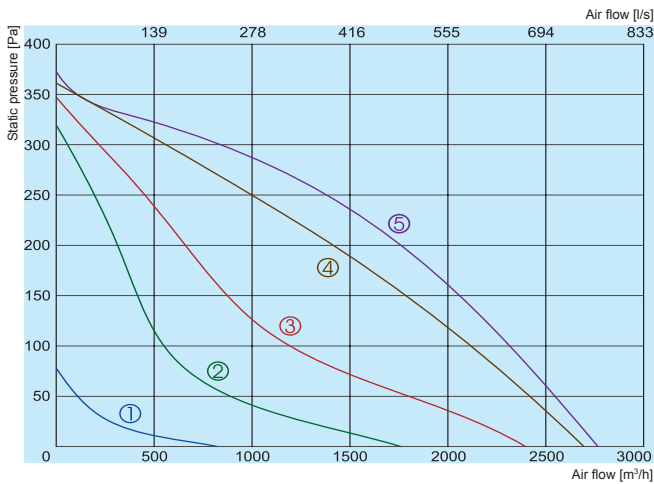

- ① 80V
- ② 120V
- ③ 140V
- ④ 170V
- ⑤ 230V

### VSV 355-4 L1

Inlet  
Outlet  
Surrounding

LWA total, dB(A)	Lwa, dB(A)						
	125 Hz	250 Hz	500 Hz	1 kHz	2 kHz	4 kHz	8 kHz
Inlet	64	49	57	59	56	55	51
Outlet	66	56	60	57	60	57	53
Surrounding	68	57	61	61	62	58	54

Measured at 2230 m³/h, 124 Pa

### VSVI 355-4 L1

Inlet  
Outlet  
Surrounding

LWA total, dB(A)	Lwa, dB(A)						
	125 Hz	250 Hz	500 Hz	1 kHz	2 kHz	4 kHz	8 kHz
Inlet	63	48	55	59	55	54	49
Outlet	64	55	58	57	59	56	51
Surrounding	67	56	60	61	60	58	53

Measured at 2230 m³/h, 124 Pa

## VSV/VSVI 355-4 L3

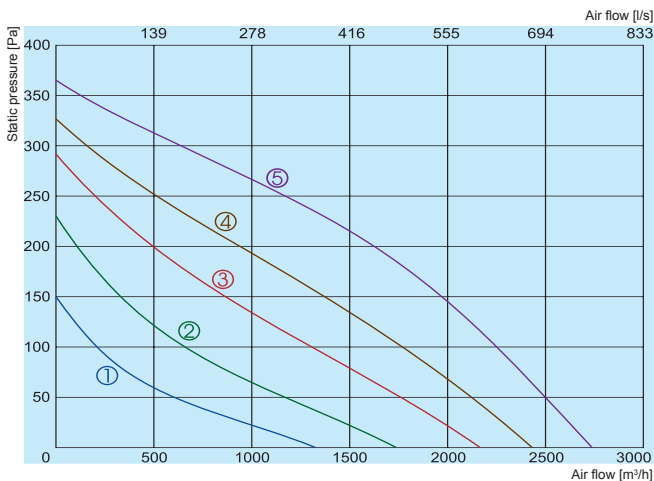

- ① 130V
- ② 170V
- ③ 220V
- ④ 270V
- ⑤ 400V

### VSV 355-4 L3

Inlet  
Outlet  
Surrounding

LWA total, dB(A)	Lwa, dB(A)						
	125 Hz	250 Hz	500 Hz	1 kHz	2 kHz	4 kHz	8 kHz
Inlet	65	52	56	60	57	57	53
Outlet	66	55	57	60	59	59	51
Surrounding	69	56	58	64	63	59	55

Measured at 2278 m³/h, 102 Pa

### VSVI 355-4 L3

Inlet  
Outlet  
Surrounding

LWA total, dB(A)	Lwa, dB(A)						
	125 Hz	250 Hz	500 Hz	1 kHz	2 kHz	4 kHz	8 kHz
Inlet	64	51	54	60	56	56	51
Outlet	65	53	56	59	59	57	51
Surrounding	68	55	58	63	61	59	54

Measured at 2278 m³/h, 102 Pa

The fan characteristic curves were determined in accordance with EN ISO 5801. The sound levels were determined in accordance with DIN 45635 resp. ISO 3744 at a distance of 1 m from the fan.

The company reserves the right to make changes of technical data without prior notice

# VSV / VSVI

## VSV/VSVI 400-4 L1

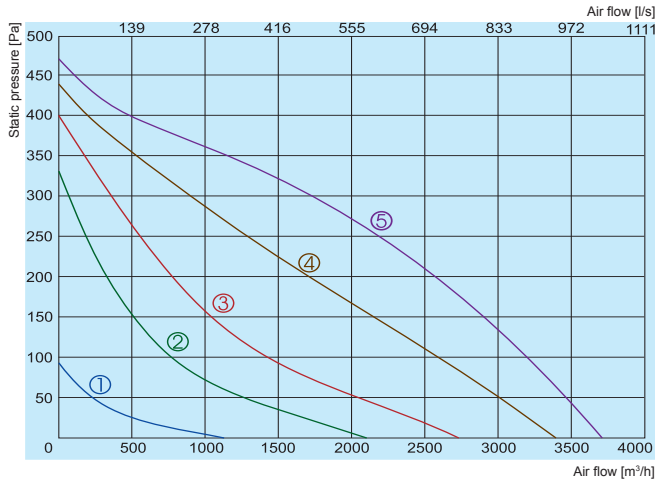

- ① 80V
- ③ 140V
- ⑤ 230V
- ② 120V
- ④ 170V

### VSV 400-4 L1

Inlet  
Outlet  
Surrounding

L <sub>wa</sub> total, dB(A)	L <sub>wa</sub> , dB(A)						
	125 Hz	250 Hz	500 Hz	1 kHz	2 kHz	4 kHz	8 kHz
Inlet	70	56	67	64	59	57	52
Outlet	69	58	63	61	62	59	52
Surrounding	72	60	67	66	64	61	56

Measured at 2897 m<sup>3</sup>/h, 160 Pa

### VSVI 400-4 L1

Inlet  
Outlet  
Surrounding

L <sub>wa</sub> total, dB(A)	L <sub>wa</sub> , dB(A)						
	125 Hz	250 Hz	500 Hz	1 kHz	2 kHz	4 kHz	8 kHz
Inlet	69	54	66	63	57	57	51
Outlet	67	57	61	61	60	58	50
Surrounding	71	59	67	65	62	61	54

Measured at 2897 m<sup>3</sup>/h, 160 Pa

## VSV/VSVI 400-4 L3

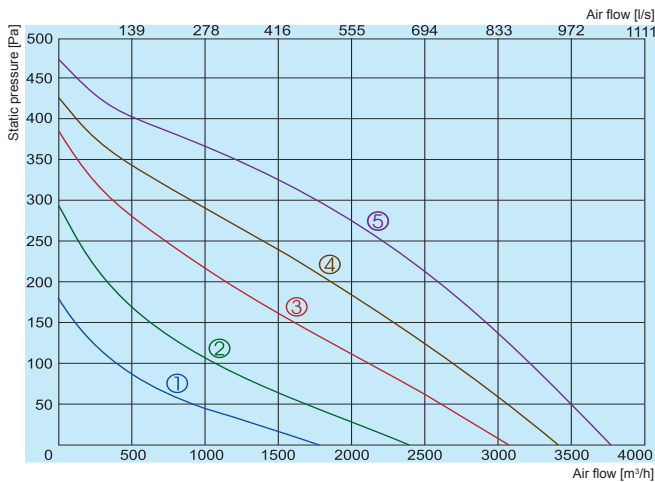

- ① 130V
- ③ 220V
- ⑤ 400V
- ② 170V
- ④ 270V

### VSV 400-4 L3

Inlet  
Outlet  
Surrounding

L <sub>wa</sub> total, dB(A)	L <sub>wa</sub> , dB(A)						
	125 Hz	250 Hz	500 Hz	1 kHz	2 kHz	4 kHz	8 kHz
Inlet	70	55	65	66	61	56	54
Outlet	70	57	65	63	60	61	52
Surrounding	73	59	69	67	64	63	55

Measured at 3009 m<sup>3</sup>/h, 145 Pa

### VSVI 400-4 L3

Inlet  
Outlet  
Surrounding

L <sub>wa</sub> total, dB(A)	L <sub>wa</sub> , dB(A)						
	125 Hz	250 Hz	500 Hz	1 kHz	2 kHz	4 kHz	8 kHz
Inlet	69	54	65	65	59	56	52
Outlet	68	56	63	63	59	60	50
Surrounding	72	58	69	66	62	63	53

Measured at 3009 m<sup>3</sup>/h, 145 Pa

		355-4 L1	355-4 L3	400-4 L1	400-4 L3
Voltage/Frequency	[V/Hz]	230/50	400/50	230/50	400/50
Power consumption	[kW]	0,270	0,243	0,451	0,436
Current	[A]	1,3	0,48	2,15	0,81
Speed	[min <sup>-1</sup> ]	1390	1340	1280	1320
Capacitor	[µF]	6	-	10	-
Max. airflow	[m <sup>3</sup> /h]	2770	2740	3710	3770
Min./Max. air temperature	[°C]	-25/60	-25/60	-25/60	-25/60
Weight	[kg]	31/39	31/38	33/42	32/41
Wiring diagram		No. 1	No. 2	No. 1	No. 2
Protection class:	motor	IP-54	IP-54	IP-54	IP-54
	terminal box	IP-55	IP-55	IP-55	IP-55
Comply with ERP		-	2018	-	2018

The fan characteristic curves were determined in accordance with EN ISO 5801. The sound levels were determined in accordance with DIN 45635 resp. ISO 3744 at a distance of 1 m from the fan.

## VSV/VSVI 450-4 L1

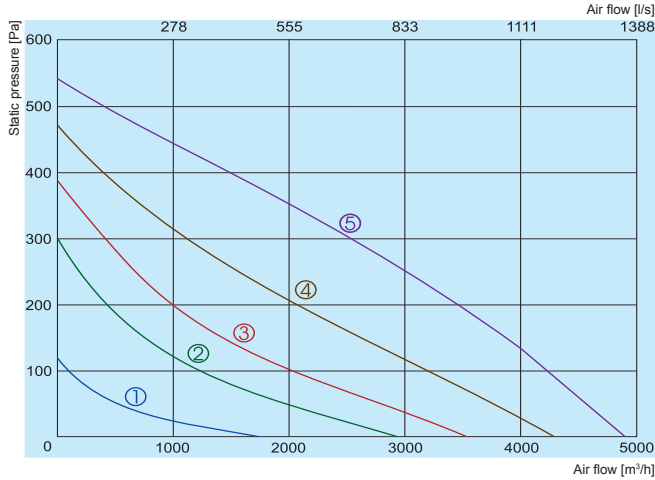

- ① 80V
- ② 120V
- ③ 140V
- ④ 170V
- ⑤ 230V

### VSV 450-4 L1

LWA total, dB(A)	Lwa, dB(A)						
	125 Hz	250 Hz	500 Hz	1 kHz	2 kHz	4 kHz	8 kHz
Inlet	72	57	66	69	60	62	55
Outlet	73	59	66	68	61	65	55
Surrounding	76	61	71	71	68	64	57

Measured at 4111 m³/h, 118 Pa

### VSVI 450-4 L1

LWA total, dB(A)	Lwa, dB(A)						
	125 Hz	250 Hz	500 Hz	1 kHz	2 kHz	4 kHz	8 kHz
Inlet	71	55	65	68	60	62	54
Outlet	72	58	64	68	60	63	52
Surrounding	75	60	71	70	66	64	55

Measured at 4111 m³/h, 118 Pa

## VSV/VSVI 450-4 L3

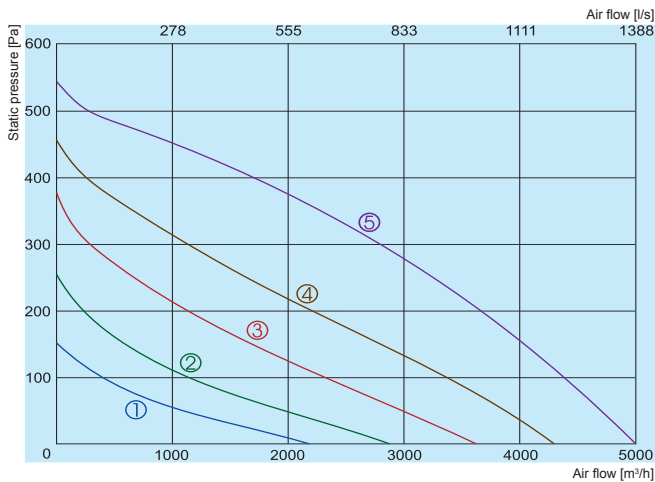

- ① 130V
- ② 170V
- ③ 220V
- ④ 270V
- ⑤ 400V

### VSV 450-4 L3

LWA total, dB(A)	Lwa, dB(A)						
	125 Hz	250 Hz	500 Hz	1 kHz	2 kHz	4 kHz	8 kHz
Inlet	73	56	64	71	61	60	54
Outlet	74	57	67	69	59	66	53
Surrounding	77	64	71	73	68	64	59

Measured at 4299 m³/h, 120 Pa

### VSVI 450-4 L3

LWA total, dB(A)	Lwa, dB(A)						
	125 Hz	250 Hz	500 Hz	1 kHz	2 kHz	4 kHz	8 kHz
Inlet	72	54	63	70	61	58	53
Outlet	73	56	65	69	58	65	51
Surrounding	76	63	71	72	66	63	57

Measured at 4299 m³/h, 120 Pa

## VSV/VSVI 450-6 L1

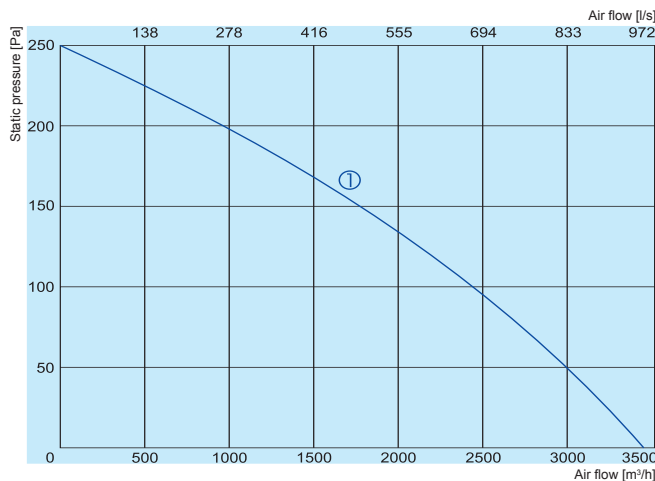

- ① 230V

### VSV 450-6 L1

LWA total, dB(A)	Lwa, dB(A)						
	125 Hz	250 Hz	500 Hz	1 kHz	2 kHz	4 kHz	8 kHz
Inlet	63	50	57	57	55	54	40
Outlet	64	52	56	58	58	57	40
Surrounding	66	54	58	61	62	57	43

Measured at 2287 m³/h, 116 Pa

### VSVI 450-6 L1

LWA total, dB(A)	Lwa, dB(A)						
	125 Hz	250 Hz	500 Hz	1 kHz	2 kHz	4 kHz	8 kHz
Inlet	62	49	55	57	54	53	38
Outlet	63	50	55	57	58	55	39
Surrounding	65	53	58	60	60	57	41

Measured at 2287 m³/h, 116 Pa

The fan characteristic curves were determined in accordance with EN ISO 5801. The sound levels were determined in accordance with DIN 45635 resp. ISO 3744 at a distance of 1 m from the fan.

The company reserves the right to make changes of technical data without prior notice

# VSV / VSVI

## VSV/VSVI 450-6 L3

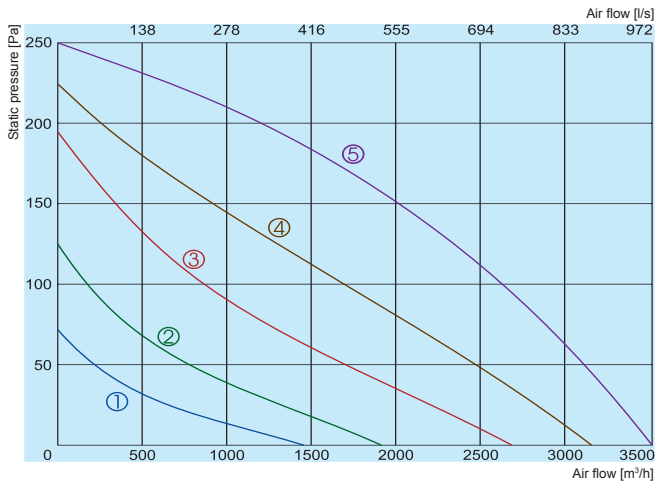

- ① 130V
- ② 170V
- ③ 220V
- ④ 270V
- ⑤ 400V

### VSV 450-6 L3

Inlet  
Outlet  
Surrounding

Lwa total, dB(A)	Lwa, dB(A)						
	125 Hz	250 Hz	500 Hz	1 kHz	2 kHz	4 kHz	8 kHz
Inlet	61	50	53	56	54	52	47
Outlet	63	51	57	57	55	56	48
Surrounding	65	53	60	59	58	57	52

Measured at 2033 m³/h, 150 Pa

### VSVI 450-6 L3

Inlet  
Outlet  
Surrounding

Lwa total, dB(A)	Lwa, dB(A)						
	125 Hz	250 Hz	500 Hz	1 kHz	2 kHz	4 kHz	8 kHz
Inlet	60	49	53	55	52	52	46
Outlet	62	49	56	56	55	54	48
Surrounding	64	52	58	59	57	56	50

Measured at 2033 m³/h, 150 Pa

		450-4 L1	450-4 L3	450-6 L1	450-6 L3
Voltage/Frequency	[V/Hz]	230/50	400/50	230/50	400/50
Power consumption	[kW]	0,628	0,652	0,243	0,267
Current	[A]	2,87	1,32	1,06	0,61
Speed	[min <sup>-1</sup> ]	1230	1250	920	880
Capacitor	[µF]	12	-	12	-
Max. airflow	[m³/h]	4880	5050	3440	3530
Min./Max. air temperature	[°C]	-25/60	-25/55	-25/60	-25/55
Weight	[kg]	50/62,5	48/61	48,562,5	47/59,5
Wiring diagram		No. 1	No. 2	No. 1	No. 2
Protection class:	motor	IP-54	IP-54	IP-54	IP-54
	terminal box	IP-55	IP-55	IP-55	IP-55
Comply with ERP		-	-	-	-

## VSV/VSVI 500-4 L3

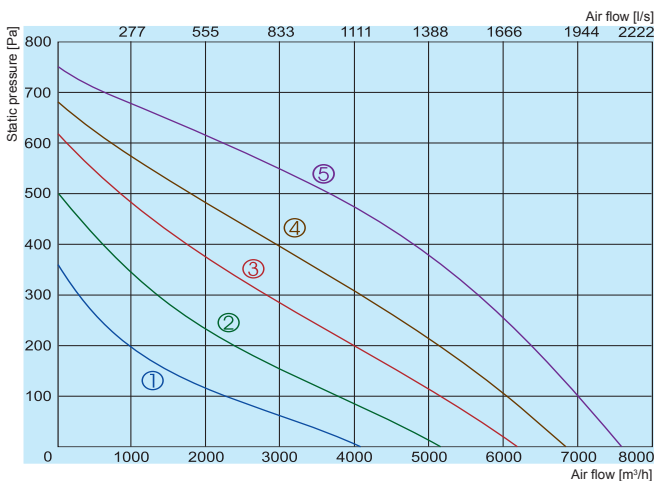

- ① 130V
- ② 170V
- ③ 220V
- ④ 270V
- ⑤ 400V

### VSV 500-4 L3

Inlet  
Outlet  
Surrounding

Lwa total, dB(A)	Lwa, dB(A)						
	125 Hz	250 Hz	500 Hz	1 kHz	2 kHz	4 kHz	8 kHz
Inlet	81	66	74	78	72	72	69
Outlet	83	67	77	78	75	73	68
Surrounding	85	70	77	81	79	74	72

Measured at 6732 m³/h, 150 Pa

### VSVI 500-4 L3

Inlet  
Outlet  
Surrounding

Lwa total, dB(A)	Lwa, dB(A)						
	125 Hz	250 Hz	500 Hz	1 kHz	2 kHz	4 kHz	8 kHz
Inlet	80	64	73	77	72	70	65
Outlet	82	66	75	78	74	72	66
Surrounding	84	69	77	80	78	74	70

Measured at 6732 m³/h, 150 Pa

The fan characteristic curves were determined in accordance with EN ISO 5801. The sound levels were determined in accordance with DIN 45635 resp. ISO 3744 at a distance of 1 m from the fan.

## VSV/VSVI 500-6 L3

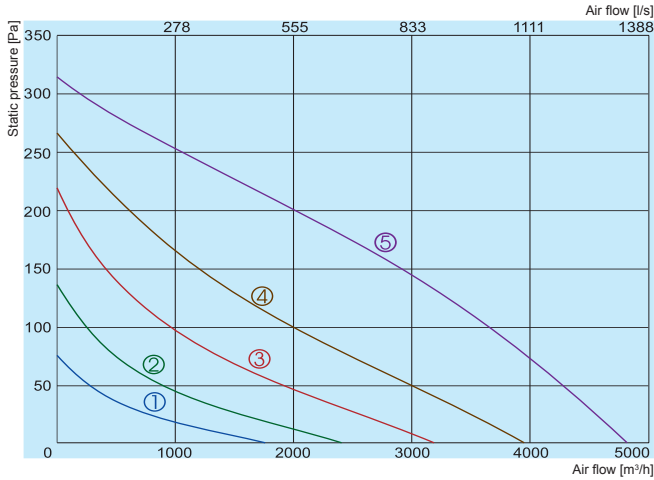

- ① 130V
- ② 170V
- ③ 220V
- ④ 270V
- ⑤ 400V

### VSV 500-6 L3

Inlet  
Outlet  
Surrounding

Lwa total, dB(A)	Lwa, dB(A)						
	125 Hz	250 Hz	500 Hz	1 kHz	2 kHz	4 kHz	8 kHz
Inlet	62	53	57	54	54	55	50
Outlet	66	51	64	56	56	57	52
Surrounding	68	55	64	59	60	58	55

Measured at 3152 m³/h, 137 Pa

### VSVI 500-6 L3

Inlet  
Outlet  
Surrounding

Lwa total, dB(A)	Lwa, dB(A)						
	125 Hz	250 Hz	500 Hz	1 kHz	2 kHz	4 kHz	8 kHz
Inlet	61	51	56	53	54	53	50
Outlet	65	49	63	55	56	55	52
Surrounding	67	53	64	57	58	57	54

Measured at 3152 m³/h, 137 Pa

## VSV/VSVI 560-4 L3

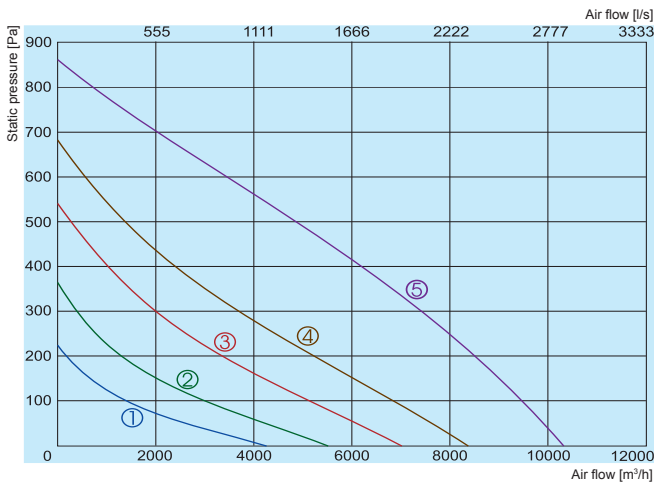

- ① 130V
- ② 170V
- ③ 220V
- ④ 270V
- ⑤ 400V

### VSV 560-4 L3

Inlet  
Outlet  
Surrounding

Lwa total, dB(A)	Lwa, dB(A)						
	125 Hz	250 Hz	500 Hz	1 kHz	2 kHz	4 kHz	8 kHz
Inlet	77	69	70	72	69	65	63
Outlet	77	69	70	71	68	69	63
Surrounding	80	71	73	74	73	70	68

Measured at 9047 m³/h, 152 Pa

### VSVI 560-4 L3

Inlet  
Outlet  
Surrounding

Lwa total, dB(A)	Lwa, dB(A)						
	125 Hz	250 Hz	500 Hz	1 kHz	2 kHz	4 kHz	8 kHz
Inlet	76	68	70	71	67	65	62
Outlet	76	67	69	70	68	67	63
Surrounding	79	70	71	74	72	69	66

Measured at 9047 m³/h, 152 Pa

## VSV/VSVI 560-6 L3

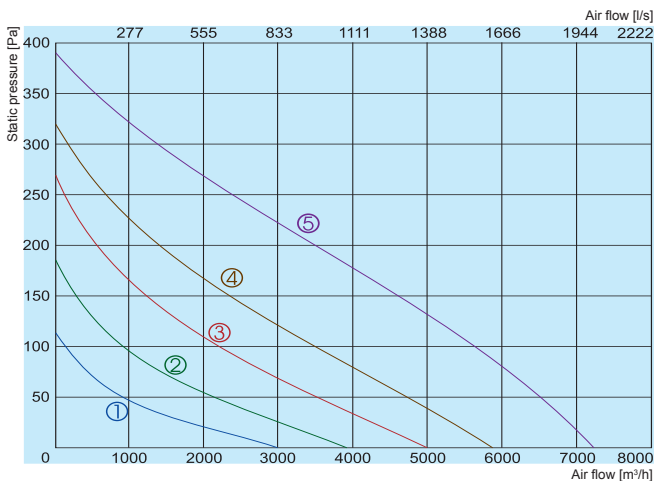

- ① 130V
- ② 170V
- ③ 220V
- ④ 270V
- ⑤ 400V

### VSV 560-6 L3

Inlet  
Outlet  
Surrounding

Lwa total, dB(A)	Lwa, dB(A)						
	125 Hz	250 Hz	500 Hz	1 kHz	2 kHz	4 kHz	8 kHz
Inlet	63	52	57	53	55	55	56
Outlet	63	53	55	58	56	56	53
Surrounding	66	55	58	59	59	58	57

Measured at 4773 m³/h, 169 Pa

### VSVI 560-6 L3

Inlet  
Outlet  
Surrounding

Lwa total, dB(A)	Lwa, dB(A)						
	125 Hz	250 Hz	500 Hz	1 kHz	2 kHz	4 kHz	8 kHz
Inlet	62	51	55	53	54	54	48
Outlet	63	52	55	57	54	56	52
Surrounding	65	54	58	58	57	58	56

Measured at 4773 m³/h, 169 Pa

The fan characteristic curves were determined in accordance with EN ISO 5801. The sound levels were determined in accordance with DIN 45635 resp. ISO 3744 at a distance of 1 m from the fan.

The company reserves the right to make changes of technical data without prior notice



# VSV / VSVI

		500-4 L3	500-6 L3	560-4 L3	560-6 L3
Voltage/Frequency	[V/Hz]	400/50	400/50	400/50	400/50
Power consumption	[kW]	1,242	0,388	1,798	0,628
Current	[A]	2,31	0,79	3,47	1,09
Speed	[min <sup>-1</sup> ]	1330	840	1180	800
Max. airflow	[m <sup>3</sup> /h]	7584	4810	10330	7215
Min./Max. air temperature	[°C]	-25/55	-25/60	-25/50	-25/40
Weight	[kg]	55,5/65	49/59	90,5/109	80/98
Wiring diagram		No. 2	No. 2	No. 2	No. 2
Protection class:	motor	IP-54	IP-54	IP-54	IP-54
	terminal box	IP-55	IP-55	IP-55	IP-55
Comply with ERP		-	-	-	-

## VSV/VSVI 630-4 L3

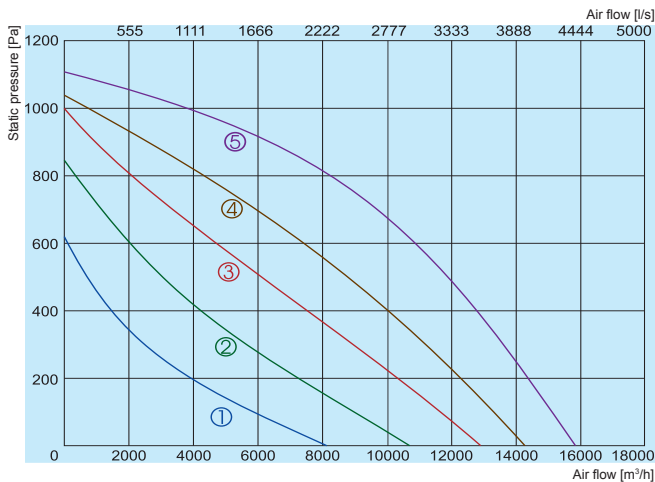

- ① 130V      ③ 220V      ⑤ 400V  
 ② 170V      ④ 270V

### VSV 630-4 L3

Inlet  
 Outlet  
 Surrounding

Lwa total, dB(A)	Lwa, dB(A)						
	125 Hz	250 Hz	500 Hz	1 kHz	2 kHz	4 kHz	8 kHz
Inlet	85	72	77	82	77	77	69
Outlet	87	73	79	83	80	77	73
Surrounding	90	76	82	86	82	79	75

Measured at 14077 m<sup>3</sup>/h, 242 Pa

### VSVI 630-4 L3

Inlet  
 Outlet  
 Surrounding

Lwa total, dB(A)	Lwa, dB(A)						
	125 Hz	250 Hz	500 Hz	1 kHz	2 kHz	4 kHz	8 kHz
Inlet	84	70	76	81	77	75	68
Outlet	85	71	77	82	78	76	69
Surrounding	88	74	80	85	79	76	71

Measured at 14077 m<sup>3</sup>/h, 242 Pa

## VSV/VSVI 630-6 L3

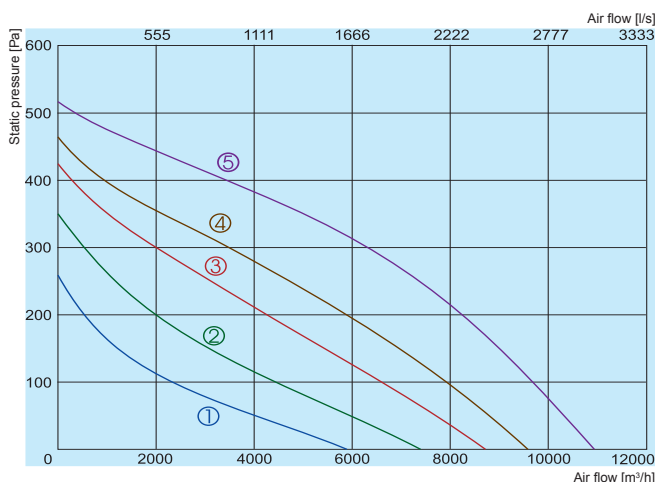

- ① 130V      ③ 220V      ⑤ 400V  
 ② 170V      ④ 270V

### VSV 630-6 L3

Inlet  
 Outlet  
 Surrounding

Lwa total, dB(A)	Lwa, dB(A)						
	125 Hz	250 Hz	500 Hz	1 kHz	2 kHz	4 kHz	8 kHz
Inlet	73	58	69	68	59	62	58
Outlet	73	59	71	63	62	61	58
Surrounding	75	61	71	70	64	63	62

Measured at 8003 m<sup>3</sup>/h, 201 Pa

### VSVI 630-6 L3

Inlet  
 Outlet  
 Surrounding

Lwa total, dB(A)	Lwa, dB(A)						
	125 Hz	250 Hz	500 Hz	1 kHz	2 kHz	4 kHz	8 kHz
Inlet	72	56	68	67	59	60	57
Outlet	72	58	69	63	60	60	56
Surrounding	74	60	71	69	62	63	60

Measured at 8003 m<sup>3</sup>/h, 201 Pa

The fan characteristic curves were determined in accordance with EN ISO 5801. The sound levels were determined in accordance with DIN 45635 resp. ISO 3744 at a distance of 1 m from the fan.

## VSV/VSVI 630-8 L3

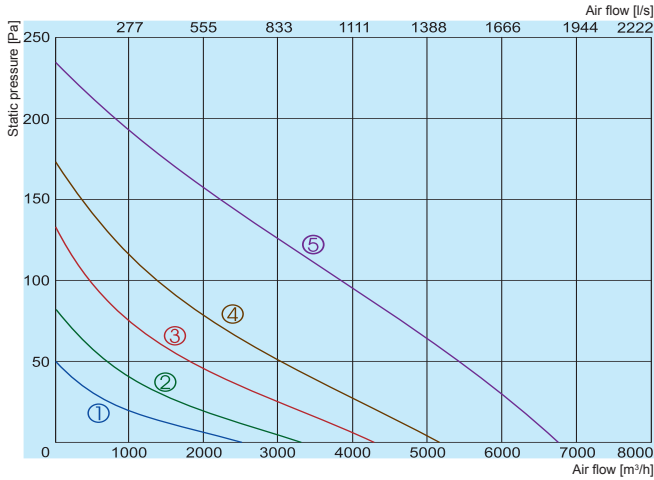

- ① 130V
- ② 170V
- ③ 220V
- ④ 270V
- ⑤ 400V

### VSV 630-8 L3

LWA total, dB(A)	Lwa, dB(A)							
	125 Hz	250 Hz	500 Hz	1 kHz	2 kHz	4 kHz	8 kHz	
Inlet	63	44	59	45	49	50	59	37
Outlet	64	48	63	50	49	52	56	37
Surrounding	66	49	63	52	53	55	59	40

Measured at 5221 m³/h, 59 Pa

### VSVI 630-8 L3

LWA total, dB(A)	Lwa, dB(A)							
	125 Hz	250 Hz	500 Hz	1 kHz	2 kHz	4 kHz	8 kHz	
Inlet	61	43	57	45	48	49	57	35
Outlet	63	46	62	50	48	51	54	35
Surrounding	65	48	63	51	51	53	58	38

Measured at 5221 m³/h, 59 Pa

## VSV/VSVI 710-6 L3

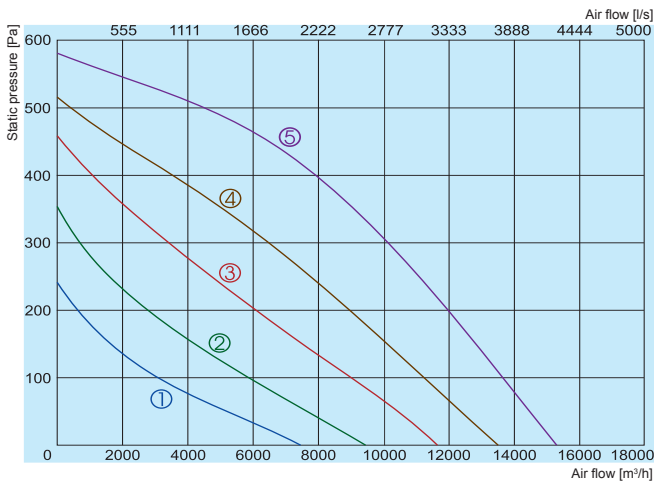

- ① 130V
- ② 170V
- ③ 220V
- ④ 270V
- ⑤ 400V

### VSV 710-6 L3

LWA total, dB(A)	Lwa, dB(A)							
	125 Hz	250 Hz	500 Hz	1 kHz	2 kHz	4 kHz	8 kHz	
Inlet	84	70	76	80	75	75	70	69
Outlet	84	70	74	81	77	74	72	71
Surrounding	87	73	76	83	79	78	76	72

Measured at 12590 m³/h, 160 Pa

### VSVI 710-6 L3

LWA total, dB(A)	Lwa, dB(A)							
	125 Hz	250 Hz	500 Hz	1 kHz	2 kHz	4 kHz	8 kHz	
Inlet	83	68	74	79	75	73	70	68
Outlet	83	69	74	80	75	74	71	69
Surrounding	85	71	75	82	77	76	76	71

Measured at 12590 m³/h, 160 Pa

## VSV/VSVI 710-8 L3

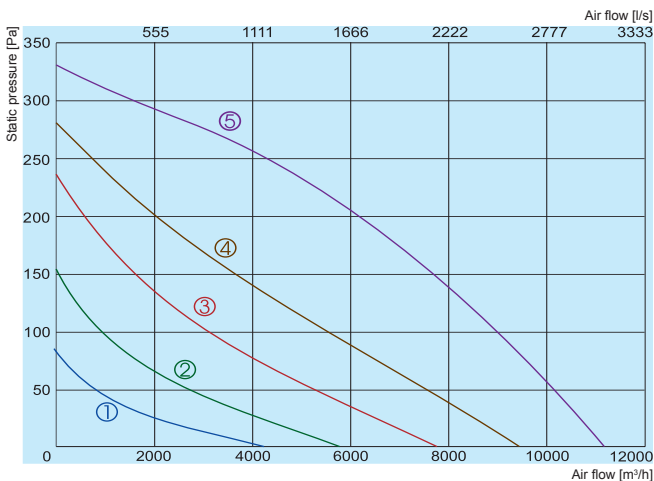

- ① 130V
- ② 170V
- ③ 220V
- ④ 270V
- ⑤ 400V

### VSV 710-8 L3

LWA total, dB(A)	Lwa, dB(A)							
	125 Hz	250 Hz	500 Hz	1 kHz	2 kHz	4 kHz	8 kHz	
Inlet	75	59	73	62	67	60	62	62
Outlet	75	60	73	65	67	62	63	59
Surrounding	78	63	76	67	69	66	64	63

Measured at 8948 m³/h, 100 Pa

### VSVI 710-8 L3

LWA total, dB(A)	Lwa, dB(A)							
	125 Hz	250 Hz	500 Hz	1 kHz	2 kHz	4 kHz	8 kHz	
Inlet	75	58	73	61	65	60	61	60
Outlet	74	59	71	65	66	61	61	57
Surrounding	77	61	75	66	69	64	64	62

Measured at 8948 m³/h, 100 Pa

The fan characteristic curves were determined in accordance with EN ISO 5801. The sound levels were determined in accordance with DIN 45635 resp. ISO 3744 at a distance of 1 m from the fan.

The company reserves the right to make changes of technical data without prior notice

# VSV / VSVI

		630-4 L3	630-6 L3	630-8 L3	710-6 L3	710-8 L3
Voltage/Frequency	[V/Hz]	400/50	400/50	400/50	400/50	400/50
Power consumption	[kW]	4,137	1,240	0,393	2,00	0,99
Current	[A]	7,18	2,73	0,9	3,9	1,93
Speed	[min <sup>-1</sup> ]	1360	880	520	890	650
Max. airflow	[m <sup>3</sup> /h]	15900	10890	6750	15300	11215
Min./Max. air temperature	[°C]	-25/50	-25/60	-25/60	-25/40	-25/40
Weight	[kg]	124/140	109/123,5	101/117,5	156/207	147,5/198,5
Wiring diagram		No. 2	No. 2	No. 2	No. 2	No. 2
Protection class:	motor	IP-54	IP-54	IP-54	IP-54	IP-54
	terminal box	IP-55	IP-55	IP-55	IP-55	IP-55
Comply with ERP		-	2018	-	-	-

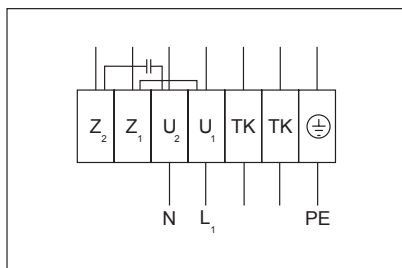

**Wiring diagram No. 1 (1~230V)**

**U<sub>1</sub>** - brown  
**U<sub>2</sub>** - blue  
**Z<sub>1</sub>** - black  
**Z<sub>2</sub>** - orange  
**TK** - white  
**PE** - yellow-green

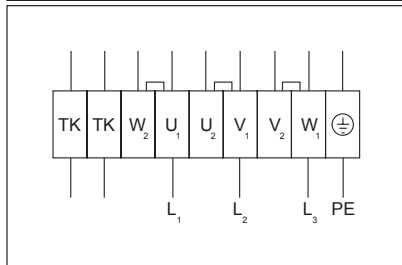

**Wiring diagram No. 2 (Δ - 3~230V)**

**U<sub>1</sub>** - brown  
**V<sub>1</sub>** - blue  
**W<sub>1</sub>** - black  
**U<sub>2</sub>** - red  
**V<sub>2</sub>** - grey  
**W<sub>2</sub>** - orange  
**TK** - white  
**PE** - yellow-green

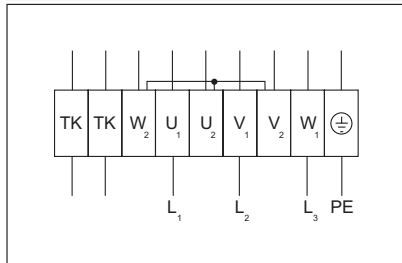

**Wiring diagram No. 2 (Y - 3~400V)**

**U<sub>1</sub>** - brown  
**V<sub>1</sub>** - blue  
**W<sub>1</sub>** - black  
**U<sub>2</sub>** - red  
**V<sub>2</sub>** - grey  
**W<sub>2</sub>** - orange  
**TK** - white  
**PE** - yellow-green

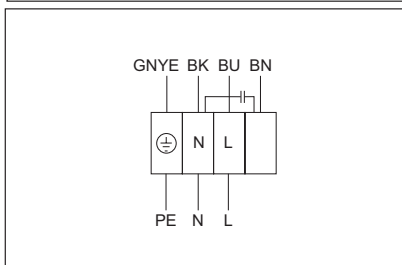

**Wiring diagram No. 3 (1~230V)**

**GNYE** - green-yellow  
**BK** - black  
**BU** - blue  
**BN** - brown  
**PE** - yellow-green

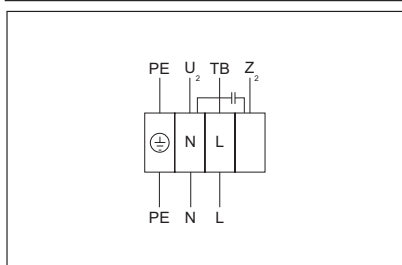

**Wiring diagram No. 4 (1~230V)**

**U<sub>2</sub>** - blue or grey  
**Z<sub>2</sub>** - black  
**TB** - brown  
**PE** - yellow-green

The fan characteristic curves were determined in accordance with EN ISO 5801. The sound levels were determined in accordance with DIN 45635 resp. ISO 3744 at a distance of 1 m from the fan.